

# TRAINING EQUIPMENT

## Fitness & Speed

### RAMROD - AGILITY POLES

Dayglo for night training

- Very flexible if hit!
- Develops side-step and evasion skills
- PVC poles with strengthened steel removable spikes for ease of insertion or used with a base for indoor/hard ground use
- Dayglo orange for evening use
- Carry bag included

2370 Set of 12 with spikes only €95

2372 Set of 12 with spikes plus bases €130



Agility practice



With spike



With base



Folds in half

### FOOT SPEED LADDERS

To develop extremely fast footwork.  
4m or 9m long.

- Fabric covered metal rods suitable for indoor and outdoor use and training with studs!
- Extremely strong

Complete set inc. quality bag.

CODE		1-3 € each	4+ € each
FSL-4	(4m)	28	23
FSL-9	(9m)	40	34



↑ Fabric covered metal rods

### STEP TRAINING HURDLES

For agility drills and plyometric jumps.  
Develops quick, strong knee lift.

STH - Set of 10

6" Yellow €66

9" Orange €72

12" Red €78

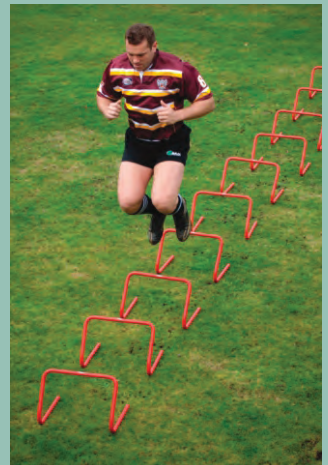
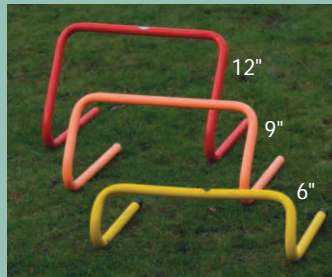

# TRAINING EQUIPMENT

Fitness & Speed, Cones

## POWER SPEED RESISTOR

Heavy duty webbing harness which is worked by one rugby player and held back by another to create resistance - the most inexpensive and very effective system of developing explosive speed and forward lean torso position.

Supplied with bag.

2380 - €12



## POP-UP CONES

- RED

2377

Set of 20 €16



## MULTIMARKERS

Heavy duty plastic domes

Colours: Red, White, Blue, Yellow - 10 per set.

2375

Set of 40 inc. carrier €29



## GRID MARKER CONES & CARRIERS

45gms durable and flexible.

Colours: Red, White, Blue, Orange, Yellow

- 10 per colour per set.

2373

Set of 50 inc. carrier

1-4	5+
€16	€15

## DOUBLE POWER SPEED CHUTE

The chute, which is connected to the waist with a padded belt, fills with air to resist sprinting so improving acceleration, endurance and direction changing. Used from distances of 10 to 200 metres.

Supplied with bag.

2378 - €30



Single chute shown

## EVASION BELT

Great for one-to-one marking and mirroring. Two players are fitted with webbing belts which are joined by a Velcro tab, and short space multi-directional quickness drills are run. The object being for the attacker to break the connection of the belt

from the defender. Instruction manual supplied.

2379 - €7

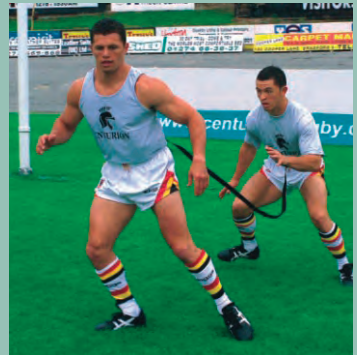

**NEW**

UV treated to prevent colour fade



# TRAINING EQUIPMENT

## Nets - Passing & Throwing

### RAM SCRUM HALF PASSING & LINE-OUT THROWING NET

The unit features fully variable targets for both the lobbed throw-in and the Torpedo throw, as well as a central target with alternative height for children and adults to practise passing from the base of the scrum. Accurate throws into any of the nets will bring the balls back to a central point, giving great satisfaction to the thrower! It is assembled in seconds and is a superb new training aid. Launched at the National Rosslyn Park School Boys 7s Tournament, it proved a great attraction with several rugby players being able to practise on the net at the same time.

Rob Smith, Director of Wasps Academy, designed this unique unit to practise line-out throwing and scrum-half passing, and it is in constant use at London Irish and London Wasps.

- Steel construction & nylon coated for long life
- Assembles in seconds
- Fully variable targets
- Central target with variable heights for children and adults
- Several players can practise on the net at the same time

2310 €725

"These innovative nets, designed by Ram International, are really great training aids - very practical and good fun. So I would urge all rugby playing schools to seriously consider purchasing them"

John Gallagher

World Cup Winner with the All Blacks in 1987 and now Headmaster, Colfe's Prep School

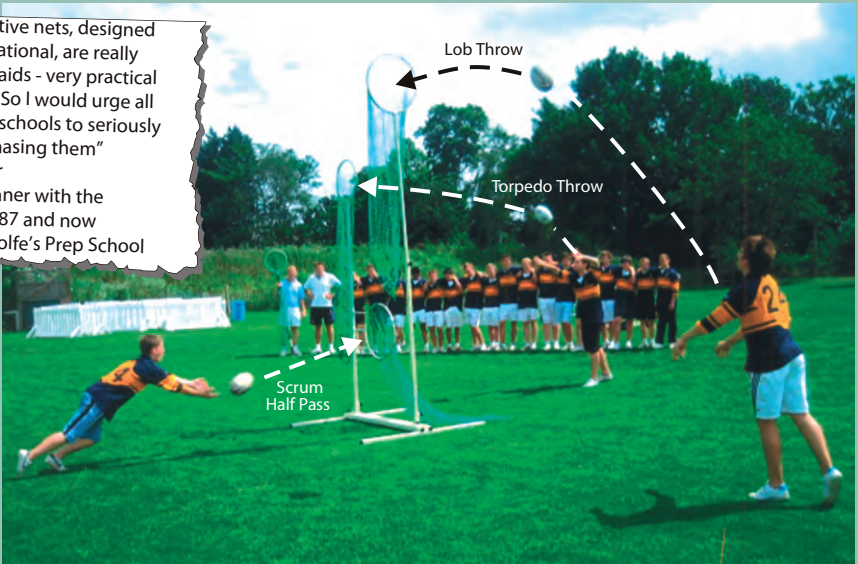

Colfe's School making full use of the Ram 3-in-1 Practice Net

### CARRY BAG

Heavy duty PVC with velcro fastening and two reinforced carry handles.

2312 €60



**Made in UK**

### MORGAN LINE-OUT MASTER

Be an expert at the line-out

- Improve Timing
- Improve Accuracy
- Improve Quick Thinking
- Steel construction & nylon coated for long life



The Line-Out Master enables the Throwers to develop their throwing accuracy at variable heights and variable distances.

The height and distance of throw can be easily adjusted at the Coaches' discretion.

Using the Morgan Line-Out Master will ensure vital possession at the Line-Out, and develop better co-ordination between the Thrower and the Jumper.

2314 €685

"A great new product which has certainly helped improve the timing, accuracy and overall quality in each of our squads' training sessions and match play. A must for any team looking to develop co-ordination and retain possession at line-outs"

Nick Beasant  
Assistant Director of Sport  
(Performance & Competitions)  
University of Exeter

Made in UK

"If I was younger I would have one in my backyard"  
Barry Williams  
Ospreys, Wales & British Lions

Height instantly adjustable by coach.

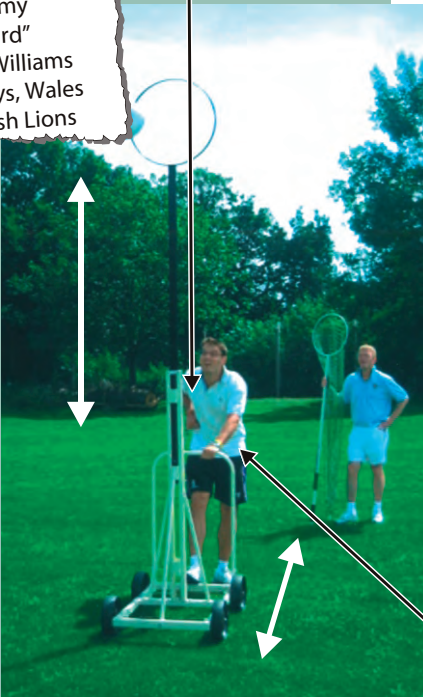

Move backwards and forwards at will.

# TRAINING EQUIPMENT

Nets - Passing, Kicking, Rucking

## INDIVIDUAL SCRUM-HALF PASSING NET

- Improve your scrum-half passing accuracy
- Have the satisfaction of getting your balls collected on all accurate passes
- Stainless steel for long life
- Polypropylene knotted net
- Total portability - fits in car
- Complete with carry bag

Size: 4' (w) x 6' 6" (h) x 4' 10" (d)

Weight: 30kg

2318 €490

Ex-England International Scrum-Half, Andy Gomarsall, sharpens-up his passes using the Ram Net.



## HAND-HELD LINEOUT PRACTICE NET

Essential product for all teams wishing to improve their throwing-in at the line-out.

- Very flexible
- Steel construction & nylon coated for long life
- Can be used in all weathers
- Supplied with a net to capture balls
- Size 8' with 18" hoop diameter

2317 €125

All Black legend, John Gallagher, uses the hand-held net to perfect line-out throwing at Colfe's School



### RAM KICKING NET

A unique net to help all kickers perfect their technique was designed in conjunction with Dave Alred, the ex-England Assistant Coach with responsibility for kicking, and developed by Ram Rugby during 2005 to be used by England's premier kickers. The Ram Kicking Net is a fabulous and affordable training aid, and a MUST to improve punting, drop-kicking and goal-kicking. It provides the kicker with the opportunity to work on his technique ensuring that he has total focus on the ball - probably the single most important factor for successful place kicking. Most importantly, kickers can practise with it at home or at their clubs, and take it with them to matches and keep it on the touchline so that either they, or the deputy kicker, can practise before or even during a match.

- Under 3 minutes to erect or dismantle - simple click-in tubes
- Stainless steel for long life
- Polypropylene knotted net
- Total portability - fits in car.
- A MUST for every club in the country and every kicker for home practise
- Complete with Carry Bag

Weight: 30kg

2315 €490

**Made in UK**

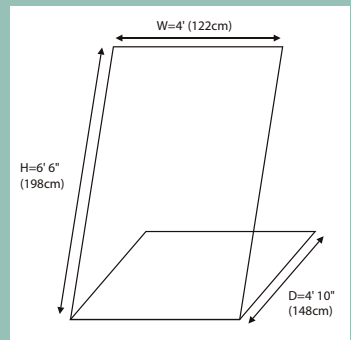

### RAM RUCKING NET

A superb coaching aid to teach correct rucking positions to all age groups.

Complete with bag for easy transportation

Size: 4 metres x 4 metres.  
5 height settings.

2316 €875



Ram rucking net in use for evening training at Richmond

# TRAINING EQUIPMENT

## Tags

### TAG BELTS

For improving handling, running, support and evasion skills.

- Full velcro surround for quick re-application
- Easily adjustable velcrostraps - no mucking around with buckles!
- Order in multiples of 10 per colour
- 5cm wide

Colours: Red, Blue, Green, Yellow

Large: 34" waist and above

Small: 32" waist and below

Can be personalised for 500+



← Tag Rugby is now very popular in India. →



	Code	10-40	50-90	100+
Large	2360	€4.50 ea	€4.00 ea	€3.50 ea
†Small	2361	€3.50 ea	€3.00 ea	€2.50 ea

†No VAT

### COMBINED TAG/BIB

- This unique new product combines the polyester bib and the tag belt into one product saving both money and hassle!
- Use the bibs without tags for any team drill and then attach tags for a game of tag rugby
- Ideal for mini rugby as bibs are easier to put on for the kids than the belts
- The bibs have an 8" by 2" Velcro panel on both sides of each bib for easy re-attachment of the tags
- Supplied in sets of 10 bibs with 20 tags

Sizes: Men, Youth, Boys

Colours: Fluorescent Orange with Blue tag  
Fluorescent Yellow with Green tag

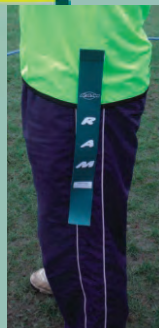

Prices per 10	Size up to	Code: 2362
Men	48"	€55
Youth	40"	€50
† Boys	34"	€40

†No VAT

## A TRAINING BIBS - POLYESTER MESH

● Set of 10 per colour

Colours: Fluorescent Yellow or Orange



## B TRAINING BIBS - REVERSIBLE

Acrylic

● Very Strong

● Set of 10 per colour combination

Colours: Red/Yellow, Green/Blue



Prices per 10	Size up to	A	B
		Std Polyester Code: 2366	Rev Acrylic Code: 2367
Men	48"	—	€88
Youth	40"	€35	€82
† Boys	34"	€30	€75

† No VAT

## C NUMBERED SLIPOVER BIBS - ACRYLIC H/W

Numbered front and back 1 - 15

Colours: Red, Blue, Green, Yellow

Sizes: Mens (up to 46"/48"), Youth (up to 38"/40"), Boys (up to 28"/30")

2368

Set of 15 to include numbers on front and back.

C	1-4 per set	5+ per set
	€125	€115

Extremely strong and perfect for contact training



# TRAINING EQUIPMENT

## Crazy Catch

### CRAZY CATCH

- Choice of two sides — insane + sane (Classic)  
insane = 2 layers of netting at different tensions, so you never know in which direction the ball will come at you  
sane = 1 layer for consistent rebound
- Hand/eye reaction trainer
- Rubber feet for use indoor & outdoor

- A** Professional (1.48m wide x 0.91m high)  
3372 Classic €215  
3372DT Double Trouble €215
- B** Wildchild (0.93m wide x 0.93m high)  
3373 Classic €140  
3373DT Double Trouble €140

"Crazy Catch is a really great training aid – every club should have one"  
Andy Gomarsall  
Ex-England International



**NEW**

Double Trouble for multi-sports & insane both sides. Use one for rugby, one for cricket and any other ball game

◀ **A** Professional ▼



Classic

USE  
HORIZONTALLY  
OR  
VERTICALLY



Double  
Trouble

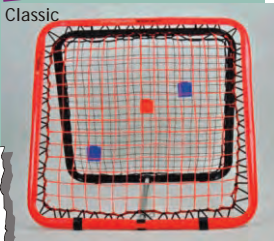

Classic



Double  
Trouble

◀ **B** Wildchild ▲

"What a really terrific training aid. Cardiff Blues just love the Crazy Catch."  
Lee Jarvis  
Academy Skills Coach,  
Cardiff Blues

All new models will now come with:

- An upgraded, self standing Activity Pack and Scorecard
- Free 1 minute challenger timer
- Plastic re-locatable targets
- Improved carry bag with shoulder strap



The Crazy Catch is endorsed by Dr Sherylle Calder, Vision Eye Specialist for the winning teams of the last two Rugby World Cups — England 2003 and South Africa 2007. Now a member of the Elite Coaching Squads for the 2012 Olympic Team.

# TRAINING EQUIPMENT

## Plyometric Tables Punch Pads, Power Cubes

### PLYOMETRIC TABLES

Perfect for plyometric jump training and power development.

- Steel construction
- EVA foam non-slip top
- Stackable

Sizes: 18", 24", 30", 36"  
2305 €340 per set of 4



**NEW EXTRA  
STRONG CONSTRUCTION  
FOR 2011/12**

### RAM POWER CUBES

The latest training aid for utilizing and developing core stabilizing muscles. Beneficial for all sports people, where power and balance are crucial. More versatile than medicine balls as can be used for weight training routines, as well as explosive power conditioning. Simple robust design available in five different weights.

- Specification: Extremely strong strapping with reinforced PVC
- Sizes: 5kg, 10kg, 15kg, 20kg, 25kg and 30kg
- Colours: Black with different weights clearly printed

Code	Size	Weight	€
4330	28" x 9" x 9"	5kg	54
4331	28" x 9" x 9"	10kg	57
4332	28" x 9" x 9"	15kg	59
4333	28" x 9" x 9"	20kg	62
4334	28" x 9" x 9"	25kg	64
4335	28" x 9" x 9"	30kg	71

### PUNCH PADS

per pair



Dick Best, former England Coach says "I just love the Punch Pads - what a clever way to build-up arm speed and shoulder strength"

CODE	1-4 € each	5+ € each
2335	25	23



**Made in  
UK**

# TRAINING EQUIPMENT

## Medicine Balls, Skipping Ropes

### MEDICINE BALLS

- Ideal for long term athletic development
- Perfect for developing core strength to help prevent injury whilst maximising power
- Can be used as part of Plyometric program
- Top specification
- Toxic free and latex free
- Special synthetic rubber with high weight density
- Excellent and safe grip
- Approved by IAAF



STANDARD				WITH HANDLE		
Code	Colour	Price Each	Weight	Code	Colour	Price Each
2385	Red	€14	1kg	2385H	Purple	€18
2386	Green	€19	2kg	2386H	Orange	€22
2387	Crimson	€24	3kg	2387H	Blue	€27
2388	Blue	€27	4kg	2388H	Grey	€30
2389	Brown	€35	5kg	2389H	Pink	€33
—	—	—	6kg	2390H	Violet	€35

### SKIPPING ROPE

- Perfect for the development of co-ordination in all rugby players
- Improve the ABCs (agility, balance, co-ordination and speed) in the Long Term Athlete Development program
- Specially developed for speed skipping

SK1 €8

